

MIDWEST RAKE®

COATINGS APPLICATION TOOLS, APPLICATORS & SUPPLIES



FAMILY OWNED AMERICAN TOOL COMPANY SINCE 1872

MIDWEST RAKE®

- **Innovative high quality tools for the coatings industry.**
- **Widest selection of pro-grade tools and supplies for applying coatings and decorative concrete.**
- **Smart new merchandising solutions and displays.**
- **Dedicated and knowledgeable local sales support to help you grow your business.**



Seymour Midwest is a family-owned, global supplier to the hand-tools market, providing both innovative solutions and time-tested products from our manufacturing facilities in Indiana and Tennessee.

The quality, dependability, and performance of our products meet the high standards of those who use tools everyday: contractors, handymen, farmers, ranchers, landscapers and others. Our diverse selection of products and brands allows our customers to order all of their tool needs from a single source.

Beyond best-in-class products, Seymour Midwest is also known as a leader in outstanding customer service, product training, and technical support in all of our business segments.

As a family-owned company, we believe in the values of integrity, quality, commitment, and innovation. We work hard to achieve performance that sets a standard of excellence and to build relationships with our customers that endure, not just because it is good business, but because it is the right thing to do. Today the family-owned company sells over 3,500 tools and 8,000 different repair handles to customers worldwide.

The Midwest Rake® brand is proud to be one of the “founding fathers” in manufacturing quality tools for those contractors who apply and finish protective industrial and marine floor and surface coatings and those concrete “artisans” who have changed the world of concrete forever with their decorative concrete talents.

Footwear	4-5
Squeegees	
<i>Speed Squeegee</i> ®	6
<i>EasySqueegee</i> ®	7
<i>Speed Squeegee</i> ® HD.....	8-9
<i>Application Squeegees / Replacement Blades</i>	10-11
<i>Miscellaneous</i>	12
 CAM® / Gauge / Notched Rakes.....	 13-15
 Trowels, Scrapers, Smoothers & Spreaders.....	 16-17
 Spiked & Ribbed Rollers	 18-19
 Roller Covers & Frames	
<i>Assurance</i> ® & <i>Specialty Roller Covers</i>	20
<i>Roller Covers, Rollers & Frames</i>	21-22
<i>Accessories</i>	22
 Microfiber Pad & T-Bar Systems.....	 22
 Poles & Extension Handles	 23
 Mixers	 24
 Miscellaneous Tools.....	 24-25
 Brooms, Pegs & Leveling Kits	 26
 Merchandising Solutions	 27

SURESPIKES®

SIMPLE CHANGES... **BIG DIFFERENCE!**

Our **SURESPIKES®** spiked shoes are certain to become the industry standard when compared to competitive "one-size-fits-all" polypropylene footwear available today.

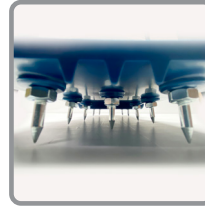

ANGLED SPIKES PROVIDE MORE STABILITY AND DECREASE THE CHANCES OF SLIPPING & FALLING (PATENT PENDING)



1-INCH HARDENED STEEL SPIKES AND NYLOC NUTS PROVIDE IMPROVED DURABILITY AND SPIKES STAY SHARPER LONGER



TOE SPIKES PREVENT THE TIP OF THE SHOE FROM CONTACTING THE FLOOR

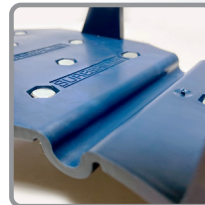

FLEXIBLE LIVING HINGE PROVIDES COMFORT & FLEXIBILITY



TUG & SNUG RUBBER STRAPS ARE QUICK, EASY, AND EFFICIENT WHEN COMPARED TO CLOTH STRAPS AND BUCKLES



"ONE-SIZE-FITS-ALL" IS PROVEN TO FIT ALMOST ANY SIZE SHOE OR BOOT

ITEM #	DESCRIPTION	PACK QTY
46195	SURESPIKES® Spiked Shoe	6
46198	Replacement Spikes for 46195 (Set of 28 - 14 for Each Shoe)	1
46199	Replacement Straps for 46195 (Set of 4 - 2 for Each Shoe)	1

Black Spiked Shoes

- Durable solvent-resistant polypropylene
- Snap-lock buckle system
- Sharp or rounded tip spikes
- 3/4", 1", 1-1/2" & 2" spike lengths
- 13 specially placed spikes per shoe
- Replacement spikes (see below)



A. / B. / C. / D. / E.

Steel Spiked Shoes

- More flexible and durable
- Snap-lock buckle system
- 3/4" or 1" spike lengths
- Replacement spikes (see below)

Non-puncturing rounded tip available



F. / G.

Red "Acid-Resistant" Spiked Shoes

- 3/4" acid-resistant stainless steel spikes
- Acid-resistant foot beds
- Snap-lock buckle system
- Replacement sharp spikes (see below)



H.

ITEM #	DESCRIPTION	PACK QTY
A. 46106	Black Spiked Shoes 3/4" Sharp Spikes (Pair)	1
B. 46107	Black Spiked Shoes 1" Sharp Spikes (Pair)	1
C. 46110	Black Spiked Shoes 1-1/2" Sharp Spikes (Pair)	1
D. 46111	Black Spiked Shoes 2" Sharp Spikes (Pair)	1

ITEM #	DESCRIPTION	PACK QTY
E. 46112	Black Spiked Shoes 1" Rounded Spikes (Pair)	1
F. 46103	Steel Spiked Shoes with 3/4" Sharp Spikes (Pair)	1
G. 46104	Steel Spiked Shoes with 1" Sharp Spikes (Pair)	1
H. 46108	Red "Acid-Resistant" Sharp Spiked Shoes (Pair)	1
46125	3/4" Sharp Tip Replacement Spikes for A & E (Set of 26 - 13 / Shoe)	1



SHARP SPIKED STYLE

3/4" - FOR RESINOUS / EPOXY FLOOR. COATING INSTALLATION. MARK-FREE INSTALLATIONS. SHARP OR ROUNDED REPLACEMENT SPIKES ARE AVAILABLE.

ITEM #	DESCRIPTION	PACK QTY
46170	Spiked Shoes - 3/4" Sharp - Small	1
46171	Spiked Shoes - 3/4" Sharp - Medium	1
46172	Spiked Shoes - 3/4" Sharp - Large	1
46173	Spiked Shoes - 3/4" Sharp - Extra-Large	1
46131	Replacement Spikes - 3/4" Sharp (Set of 32 - 16 Per Shoe)	1
46132	Replacement Spikes - 1" Rounded (Set of 32 - 16 Per Shoe)	1



FLAT STYLE

FOR CONCRETE INSTALLATION. NO TREAD MARKS OR HEEL MARKS. IDEAL FOR DECORATIVE CONCRETE STAMPING AND GENERAL SURFACE TROWELING.

ITEM #	DESCRIPTION	PACK QTY
46161	Concrete Finishing Shoe - Medium	1
46162	Concrete Finishing Shoe - Large	1
46163	Concrete Finishing Shoe - Extra- Large	1

"Flexible Bed" Spiked Shoes

- Revolutionary - perfect fit, balance and flexibility
- For use with high performance floor coatings
- The safest spiked shoes available
- Snap-lock buckle system

Made for Midwest Rake® by



Korkers



- 20 replaceable spikes per shoe
- Toe and heel guards
- Fits like a shoe

SHARP TIP Flexible Bed Spiked Shoes

ITEM #	DESCRIPTION	PACK QTY
46141	Size Medium (Shoe size 8 to 9-1/2)	1
46142	Size Large (Shoe size 10 to 11-1/2)	1
46143	Size Extra-Large (Shoe size 12 to 13-1/2)	1
46129	Replacement Spikes (set of 40)	1

1/2" spike length on sharp tip

ROUNDED TIP Flexible Bed Spiked Shoes

ITEM #	DESCRIPTION	PACK QTY
46151	Size Medium (Shoe size 8 to 9-1/2)	1
46152	Size Large (Shoe size 10 to 11-1/2)	1
46153	Size Extra-Large (Shoe size 12 to 13-1/2)	1
46130	Replacement Spikes (set of 40)	1

7/8" spike length for use with high-build, cementitious and decorative concrete toppings. No more punctured primer coats!

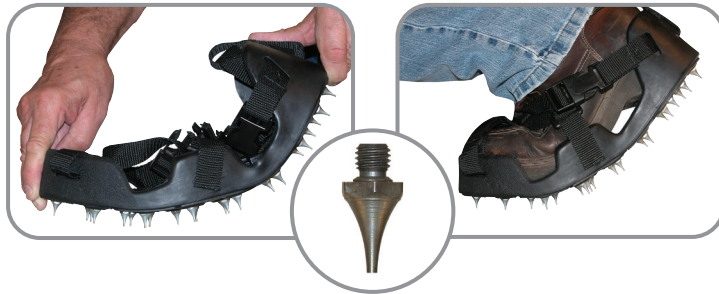

SIZING - SELECT YOUR SIZE TO FIT OVER EITHER BOOTS OR SNEAKERS

SMALL

FITS BOOT SIZE 8 AND UNDER
FITS SNEAKER SIZE 8 AND UNDER

MEDIUM

FITS BOOT SIZE 9 AND UNDER
FITS SNEAKER SIZE 9 AND UNDER

LARGE

FITS BOOT SIZES 10 TO 11
FITS SNEAKER SIZE 10 TO 12

EXTRA-LARGE

FITS BOOT SIZES 12 TO 16
FITS SNEAKER SIZE 13 TO 16



SPEEDSQUEEGEE®

RAISING THE BAR FOR THE ENTIRE INDUSTRY

- Designed for applying resinous flooring materials such as epoxy and urethanes.
- Provides industry leading precision, predictability and versatility when compared to competitive products.
- Unique Color Coded Identification of WFT (in mils) and WFSR FT² / Gal.
- Four unique styles of blades (Flat Flex, Flat Stiff, Scalloped Notched and V-Notched) provide the installer with options in the field as to how to best accomplish their project.

COMPLETE READY TO USE TOOL, ONE-PIECE FRAME & BLADE (NOT REPLACEABLE)
POLYMER FRAME WITH THREADED HANDLE ADAPTER
AVAILABLE IN 2 WIDTHS - 18" AND 24"

 **FLAT FLEXIBLE**

 **FLAT STIFF**

 **5-7 WFT MILS**
WFSR: 230-320 FT² / GAL

 **8-12 WFT MILS**
WFSR: 133-200 FT² / GAL

 **15-20 WFT MILS**
WFSR: 80-106 FT² / GAL

 **25-30 WFT MILS**
WFSR: 53-64 FT² / GAL

 **40-45 WFT MILS**
WFSR: 36-40 FT² / GAL

 **50-60 WFT MILS**
WFSR: 26-32 FT² / GAL

ITEM #	DESCRIPTION	PACK QTY
47750	18" Speed Squeegee®, Flat Stiff Blade	6
47751	18" Speed Squeegee®, Flat Flex Blade	6
47756	18" Speed Squeegee®, 5-7 WFT Mils Blade	6
47759	18" Speed Squeegee®, 8-12 WFT Mils Blade	6
47762	18" Speed Squeegee®, 15-20 WFT Mils Blade	6
47765	18" Speed Squeegee®, 25-30 WFT Mils Blade	6
47768	18" Speed Squeegee®, 40-45 WFT Mils Blade	6
47771	18" Speed Squeegee®, 50-60 WFT Mils Blade	6
47850	24" Speed Squeegee®, Flat Stiff Blade	6
47851	24" Speed Squeegee®, Flat Flex Blade	6
47856	24" Speed Squeegee®, 5-7 WFT Mils Blade	6
47859	24" Speed Squeegee®, 8-12 WFT Mils Blade	6
47862	24" Speed Squeegee®, 15-20 WFT Mils Blade	6
47865	24" Speed Squeegee®, 25-30 WFT Mils Blade	6
47868	24" Speed Squeegee®, 40-45 WFT Mils Blade	6
47871	24" Speed Squeegee®, 50-60 WFT Mils Blade	6

Wet Film Spread Rates (WFSR FT² / Gal.) are not absolute but provided to assist blade selection. Many factors can contribute to the actual WFSR including pressure exerted on the blade, porosity of the substrate being coated, material used and if and how the back-roll is completed. If you have any questions or would like to discuss the particulars of your project please contact us.

EASYSQUEEGEE®

CLEANABLE & REUSABLE

US PATENT 10,165,923

PRECISION APPLICATION SQUEEGEE SYSTEM

A CLEANABLE & REUSABLE PRECISION APPLICATION SQUEEGEE SYSTEM

The **self-locating** & **self-leveling** blades ensure your blade is straight, level and in perfect contact with the floor every time.

The eight unique engineered blades provide a level of versatility and jobsite application options not currently available from any competitive application squeegee tool today.

Cured Coatings Release technology ensures the frame is reusable regardless of the material (Epoxy and Urethanes) you're putting down with the **EasySqueegee®**, once cured the frame can be cleaned.

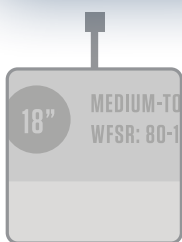

INTELLIGENT BLADE IDENTIFICATION

All blades inscribed with WFT and WFSR information.



SELF-LEVELING BLADES

Accurate and predictable Wet Film Thickness every time.



SELF-LOCATING BLADES

Designed to provide industry leading accuracy.

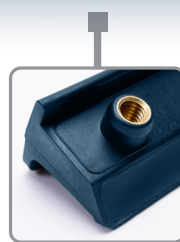

PROTECTED THREADS AND FASTENERS

Eliminates material contact with threads.



STEEL THUMB SCREWS REPLACE NUTS

Features Cured Coatings Release Technology for cleanability.



FLAT FLEXIBLE



FLAT STIFF



5-7 WFT MILS
WFSR: 230-320 FT² / GAL



8-12 WFT MILS
WFSR: 133-200 FT² / GAL



15-20 WFT MILS
WFSR: 80-106 FT² / GAL



25-30 WFT MILS
WFSR: 53-64 FT² / GAL



40-45 WFT MILS
WFSR: 36-40 FT² / GAL



50-60 WFT MILS
WFSR: 26-32 FT² / GAL

ITEM #	DESCRIPTION	PACK QTY
78255	18" EasySqueegee® Frame with Threaded Handle Adapter	1
79853	18" EasySqueegee® Blade, Flat Stiff	1
79850	19" EasySqueegee® Blade, Flat Flexible	1
79856	18" EasySqueegee® Blade, 5-7 WFT MilS	1
79859	18" EasySqueegee® Blade, 8-12 WFT MilS	1
79862	18" EasySqueegee® Blade, 15-20 WFT MilS	1
79865	18" EasySqueegee® Blade, 25-30 WFT MilS	1
79868	18" EasySqueegee® Blade, 40-45 WFT MilS	1
79871	18" EasySqueegee® Blade, 50-60 WFT MilS	1
78256	26" EasySqueegee® Frame with Threaded Handle Adapter	1
79854	26" EasySqueegee® Blade, Flat Stiff	1
79851	27" EasySqueegee® Blade, Flat Flexible	1
79857	26" EasySqueegee® Blade, 5-7 WFT MilS	1
79860	26" EasySqueegee® Blade, 8-12 WFT MilS	1
79863	26" EasySqueegee® Blade, 15-20 WFT MilS	1
79866	26" EasySqueegee® Blade, 25-30 WFT MilS	1
79869	26" EasySqueegee® Blade, 40-45 WFT MilS	1
79872	26" EasySqueegee® Blade, 50-60 WFT MilS	1
79849	Replacement Fasteners for EasySqueegee® (Bag of 7)	1

Wet Film Spread Rates (WFSR FT² / Gal.) are not absolute but provided to assist blade selection. Many factors can contribute to the actual WFSR including pressure exerted on the blade, porosity of the substrate being coated, material used and if and how the back-roll is completed. If you have any questions or would like to discuss the particulars of your project please contact us.

SPEEDSQUEEGEE® HD

RED RUBBER

The choice among epoxy flooring, deck coating, and decorative concrete contractors who prefer a softer blade. Red rubber provides excellent chemical resistance and is non-marking. Has a heavy-duty polymer threaded handle adapter.

GRAY EPDM

A favorite among epoxy flooring, deck coating and decorative concrete contractors. Gray EPDM has excellent chemical resistance, is moderately stiff and is non-marking. Has a heavy-duty polymer threaded handle adapter.

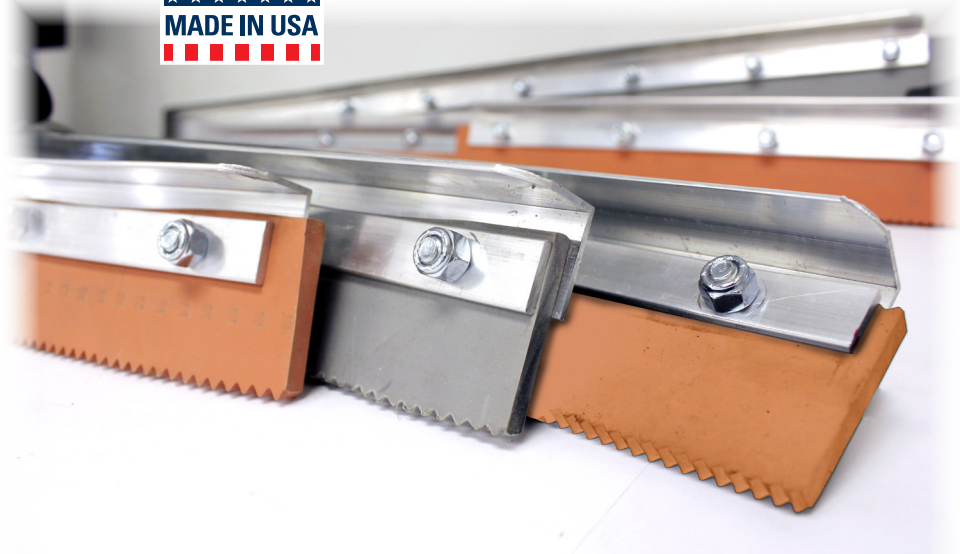

THREADED HANDLE ADAPTER

ITEM #	DESCRIPTION	PACK QTY
47174	Speed Squeegee® HD, 24", Flat, Gray EPDM Blade, Threaded Handle Adapter	6
47175	Speed Squeegee® HD, 24", 1/8" W x 1/16" D (8-12 mil), Gray EPDM Blade, Threaded Handle Adapter	6
47176	Speed Squeegee® HD, 24", 3/16 W x 3/32" D (15-20 mil), Gray EPDM Blade, Threaded Handle Adapter	6
47177	Speed Squeegee® HD, 24", 1/4" W x 1/8" D (20-28 mil), Gray EPDM Blade, Threaded Handle Adapter	6
47150	Speed Squeegee® HD, 24", Flat, Red Rubber Blade, Threaded Handle Adapter	6
47151	Speed Squeegee® HD, 24", 1/8" W x 1/16" D (8-12 mil), Red Rubber Blade, Threaded Handle Adapter	6
47152	Speed Squeegee® HD, 24", 3/16 W x 3/32" D (15-20 mil), Red Rubber Blade, Threaded Handle Adapter	6
47153	Speed Squeegee® HD, 24", 1/4" W x 1/8" D (20-28 mil), Red Rubber Blade, Threaded Handle Adapter	6

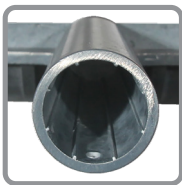

TAPERED HANDLE ADAPTER

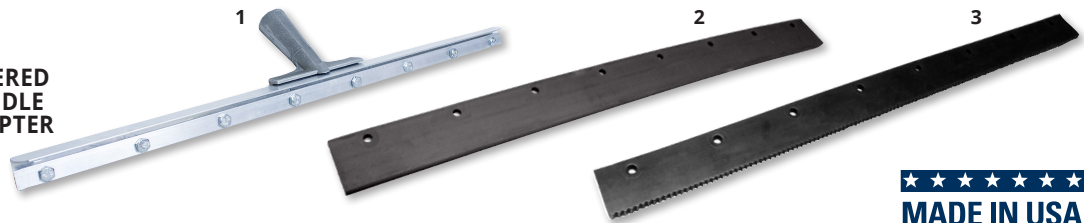

ITEM #	DESCRIPTION	PACK QTY
47540	Speed Squeegee® HD Frame, 30" Aluminum Head, Tapered Handle Adapter	6
47541	Speed Squeegee® HD, 30", Flat, Black Neoprene Blade, Tapered Handle Adapter	6
47542	Speed Squeegee® HD, 30", 1/8" W x 1/16" D (8-12 mil), Black Neoprene Blade, Tapered Handle Adapter	6
47543	Speed Squeegee® HD, 30", 3/16 W x 3/32" D (15-20 mil), Black Neoprene Blade, Tapered Handle Adapter	6
47544	Speed Squeegee® HD, 30", 1/4" W x 1/8" D (20-28 mil), Black Neoprene Blade, Tapered Handle Adapter	6
47545	Speed Squeegee® HD, 30", 3/8" W x 1/4" D (30-45 mil), Black Neoprene Blade, Tapered Handle Adapter	6
47546	Speed Squeegee® HD, 30", 1/2" W x 3/8" D (46-55 mil), Black Neoprene Blade, Tapered Handle Adapter	6
47547	Speed Squeegee® HD, 30", (56-74 Mil), Black Neoprene Blade, Tapered Handle Adapter	6
47548	Speed Squeegee® HD, 30", (75+ Mil), Black Neoprene Blade, Tapered Handle Adapter	6

BLADES AND FRAME ARE SOLD SEPARATELY

SPEED SQUEEGEE® HD - PREASSEMBLED SQUEEGEES

SPEED SQUEEGEE® HD

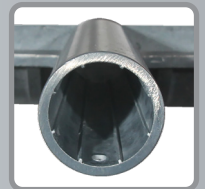

TAPERED HANDLE ADAPTER

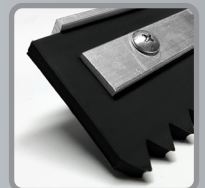

HEAVY-DUTY RUBBER BLADE

ITEM #	DESCRIPTION	PACK QTY
47511-B	Speed Squeegee® HD, 24", Tapered Adapter, Flat, Black Rubber	6
47511-B8	Speed Squeegee® HD, 24", Tapered Adapter, 1/8" W x 1/16" D (8-12 Mil), Black Rubber	6
47511-B15	Speed Squeegee® HD, 24", Tapered Adapter, 3/16" W x 3/32" D (15-20 Mil), Black Rubber	6
47511-B20	Speed Squeegee® HD, 24", Tapered Adapter, 1/4" W x 1/8" D (20-28 Mil), Black Rubber	6
47511-B30	Speed Squeegee® HD, 24", Tapered Adapter, 3/8" W x 1/4" D (30-45 Mil), Black Rubber	6
47511-B46	Speed Squeegee® HD, 24", Tapered Adapter, 1/2" W x 3/8" D (46-55 Mil), Black Rubber	6
47511-B56	Speed Squeegee® HD, 24", Tapered Adapter, (56-74 Mil), Black Rubber	6
47511-B75	Speed Squeegee® HD, 24", Tapered Adapter, (75+ Mil), Black Rubber	6
47511-G	Speed Squeegee® HD, 24", Tapered Adapter, Flat, Gray Rubber	6
47511-G8	Speed Squeegee® HD, 24", Tapered Adapter, 1/8" W x 1/16" D (8-12 Mil), Gray Rubber	6
47511-G15	Speed Squeegee® HD, 24", Tapered Adapter, 3/16" W x 3/32" D (15-20 Mil), Gray Rubber	6
47511-G20	Speed Squeegee® HD, 24", Tapered Adapter, 1/4" W x 1/8" D (20-28 Mil), Gray Rubber	6
47511-G30	Speed Squeegee® HD, 24", Tapered Adapter, 3/8" W x 1/4" D (30-45 Mil), Gray Rubber	6
47511-G46	Speed Squeegee® HD, 24", Tapered Adapter, 1/2" W x 3/8" D (46-55 Mil), Gray Rubber	6
47511-G56	Speed Squeegee® HD, 24", Tapered Adapter, (56-74 Mil), Gray Rubber	6
47511-G75	Speed Squeegee® HD, 24", Tapered Adapter, (75+ Mil), Gray Rubber	6
47512-B	Speed Squeegee® HD, 30", Tapered Adapter, Flat, Black Rubber	6
47512-B8	Speed Squeegee® HD, 30", Tapered Adapter, 1/8" W x 1/16" D (8-12 Mil), Black Rubber	6
47512-B15	Speed Squeegee® HD, 30", Tapered Adapter, 3/16" W x 3/32" D (15-20 Mil), Black Rubber	6
47512-B20	Speed Squeegee® HD, 30", Tapered Adapter, 1/4" W x 1/8" D (20-28 Mil), Black Rubber	6
47512-B30	Speed Squeegee® HD, 30", Tapered Adapter, 3/8" W x 1/4" D (30-45 Mil), Black Rubber	6
47512-B46	Speed Squeegee® HD, 30", Tapered Adapter, 1/2" W x 3/8" D (46-55 Mil), Black Rubber	6
47512-B56	Speed Squeegee® HD, 30", Tapered Adapter, (56-74 Mil), Black Rubber	6
47512-B75	Speed Squeegee® HD, 30", Tapered Adapter, (75+ Mil), Black Rubber	6
47512-G	Speed Squeegee® HD, 30", Tapered Adapter, Flat, Gray Rubber	6
47512-G8	Speed Squeegee® HD, 30", Tapered Adapter, 1/8" W x 1/16" D (8-12 Mil), Gray Rubber	6
47512-G15	Speed Squeegee® HD, 30", Tapered Adapter, 3/16" W x 3/32" D (15-20 Mil), Gray Rubber	6
47512-G20	Speed Squeegee® HD, 30", Tapered Adapter, 1/4" W x 1/8" D (20-28 Mil), Gray Rubber	6
47512-G30	Speed Squeegee® HD, 30", Tapered Adapter, 3/8" W x 1/4" D (30-45 Mil), Gray Rubber	6
47512-G46	Speed Squeegee® HD, 30", Tapered Adapter, 1/2" W x 3/8" D (46-55 Mil), Gray Rubber	6
47512-G56	Speed Squeegee® HD, 30", Tapered Adapter, (56-74 Mil), Gray Rubber	6
47512-G75	Speed Squeegee® HD, 30", Tapered Adapter, (75+ Mil), Gray Rubber	6

**IDEAL FOR HIGH VOLUME DECK COATING,
 WATERPROOFING, AND URETHANE INSTALLATIONS**
FIELD TESTED TO BE LIGHTER THAN THE COMPETITION

Application Squeegees

Step 1 - Choose the frame

Midwest Rake® branded application squeegee frames are the standard in the Protective Coating industry. These “clamp-style” frames make it easy to change blades.

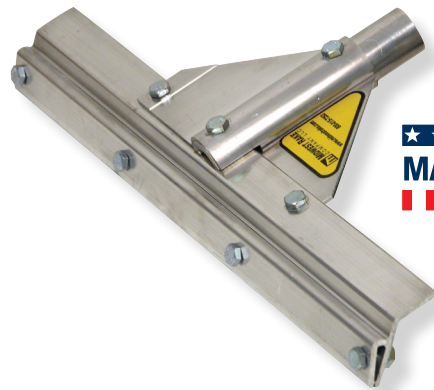

DESCRIPTION	ITEM # / 16"	ITEM # / 24"	ITEM # / 30"	ITEM # / 36"	ITEM # / 48"
Application Squeegee Frame with THA*	78000	78010	78015	78020	78040
Application Squeegee Frame with 66" PCAH**	78100	78110	78115	78120	78140
Application Squeegee Frame with 82" PCAH**	78200	78210	78215	78220	78240

*Threaded Handle Adapter **Powder-Coated Aluminum Handle

What squeegee notch width / notch depth should I use to apply 10 mils of epoxy? At Midwest Rake®, the answer is always refer to our “Nominal Wet Film Thickness Chart” to determine the appropriate notch width / notch depth required for your job. Our squeegee blades have a unique design - shallower depth notches enable Midwest Rake® squeegees to stand out from the competition ensuring a consistent and tight range of wet film thickness delivery.

**The chart conversions to the right are not absolutes and are provided to help guide blade selection. Many factors can contribute to the actual wet film thickness produced; including: pressure exerted on the blade, porosity of the substrate (concrete) being coated, material being used and if and how the back-roll is completed. If you have any questions or would like to discuss the particulars of your project - please contact us at 844-SEYMOUR and we would be more than happy to provide guidance in the application squeegee selection process.*

NOMINAL WET FILM THICKNESS CHART

DESCRIPTION	NOTCH WIDTH	NOTCH DEPTH	NOMINAL WET FILM (WFT) DELIVERED IN MILS*
1/8" V-Notch	1/8"	1/16"	8 - 12
3/16" V-Notch	3/16"	3/32"	15 - 20
1/4" V-Notch	1/4"	1/8"	20 - 28
3/8" V-Notch	3/8"	1/4"	30 - 45
1/2" V-Notch	1/2"	3/8"	46-55
56-74 Mil V-Notch			56-74
75+ Mil V-Notch			75+

Step 2a - Choose the blade, 25' rolls

Our blades are available in Black Rubber, EPDM, and Red Rubber. Most blades are “reversible” (notched on both sides). Each type is available in various notch sizes.

EXCLUSIVE
Rubber is also available by the roll.



Black Rubber



EPDM
Chemical Resistant / Non-marking



Red Rubber
Chemical Resistant / Non-marking



Our standard Black Rubber, EPDM, and Red Rubber are available in 25' rolls. Please see the chart below for product information.

DESCRIPTION	Black Rubber Notched on both sides	Standard EPDM Notched on both sides	2" Red Rubber Notched on both sides
25' Roll No-Notch (Flat) Rubber	79405	79505	79605
25' Roll 1/8" Notch Rubber	79410	79510	79610
25' Roll 3/16" Notch Rubber	79415	79515	79615
25' Roll 1/4" Notch Rubber	79420	79520	79620
25' Roll 3/8" Notch Rubber	79425	79525	79625
25' Roll 1/2" Notch Rubber	79430	79530	79630
25' Roll 56-74 Mil Notch Rubber	~	~	~
25' Roll 75+ Mil Notch Rubber	~	~	~



Black Rubber



EPDM

Chemical Resistant /
Non-marking



Red Rubber

Chemical Resistant /
Non-marking

Step 2b - Choose the blade, variable widths

Our blades are available in Black Rubber, EPDM, and Red Rubber. All blades are “reversible” (notched on both sides). Each type is available in a variety of head widths and notch sizes.

DESCRIPTION	ITEM # / 16"	ITEM # / 24"	ITEM # / 30"	ITEM # / 36"	ITEM # / 48"
Black Rubber No-Notch (Flat) Reversible Squeegee Blade	79005	79010	79013	79015	79020
Black Rubber 1/8" Notch Reversible Squeegee Blade	79025	79030	79033	79035	79040
Black Rubber 3/16" Notch Reversible Squeegee Blade	79045	79050	79053	79055	79060
Black Rubber 1/4" Notch Reversible Squeegee Blade	79065	79070	79073	79075	79080
Black Rubber 3/8" Notch Reversible Squeegee Blade	79085	79090	79093	79095	79100
Black Rubber 1/2" Notch Reversible Squeegee Blade	79105	79110	79113	79115	79120
EPDM No-Notch (Flat) Reversible Squeegee Blade	79205	79210	79213	79215	79220
EPDM 1/8" Notch Reversible Squeegee Blade	79225	79230	79233	79235	79240
EPDM 3/16" Notch Reversible Squeegee Blade	79245	79250	79253	79255	79260
EPDM 1/4" Notch Reversible Squeegee Blade	79265	79270	79273	79275	79280
EPDM 3/8" Notch Reversible Squeegee Blade	79285	79290	79293	79295	79300
EPDM 1/2" Notch Reversible Squeegee Blade	79305	79310	79313	79315	79320
Red Rubber No-Notch (Flat) Reversible Squeegee Blade	79705	79710	79713	79715	79720
Red Rubber 1/8" Notch Reversible Squeegee Blade	79725	79730	79733	79735	79740
Red Rubber 3/16" Notch Reversible Squeegee Blade	79745	79750	79753	79755	79760
Red Rubber 1/4" Notch Reversible Squeegee Blade	79765	79770	79773	79775	79780
Red Rubber 3/8" Notch Reversible Squeegee Blade	79785	79790	79793	79795	79800
Red Rubber 1/2" Notch Reversible Squeegee Blade	79805	79810	79813	79815	79820

Application Squeegees

**Frame & blade combo - you supply the handle.
For handle options see page 23.**



DESCRIPTION	ITEM # / 16"	ITEM # / 24"
Application Squeegee Frame with No-Notch (Flat) Reversible EPDM Blade with THA*	78546	78554
Application Squeegee Frame with No-Notch (Flat) Red Rubber Blade with THA*	78548	78556
Application Squeegee Frame with 1/8" Notched Reversible EPDM Blade with THA*	78118	78128
Application Squeegee Frame with 1/8" Notched Red Rubber Blade with THA*	-	78129
Application Squeegee Frame with 3/16" Notched Reversible EPDM Blade with THA*	78116	78126
Application Squeegee Frame with 3/16" Notched Red Rubber Blade with THA*	-	78323
Application Squeegee Frame with 1/4" Notched Reversible EPDM Blade with THA*	78114	78124
Application Squeegee Frame with 1/4" Notched Red Rubber Blade with THA*	-	78125
Application Squeegee Frame with 1/2" Notched EPDM Blade, THA*	-	78122

*THA=Threaded Handle Adapter

Hand-Held Squeegee

The hand-held squeegee is used to fill depressions and cracks in a floor prior to the application of any protective coating product. The blade is clamped in a durable 8" wide aluminum frame, not bolted through, making it easy to replace. The handle is a 6" non-slip vinyl grip over an aluminum core.

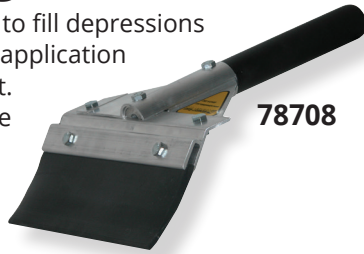

ITEM #	DESCRIPTION
78708	Hand-Held Squeegee, 3" Flexible Rounded Edge Neoprene Blade
SP50070	Replacement Blade for 78708
78709	Hand-Held Squeegee, 2" More Rigid Square Edge Neoprene Blade
SP50129	Replacement Blade for 78709
78108	8" Hand-Held Squeegee Frame

Crack Filler Squeegees

Push/Pull V-Crack Filler Squeegee

The "V" is at a 70 degree angle, using a 1/4" x 2" neoprene rubber blade. The 2" height adds greater containment and control of material.

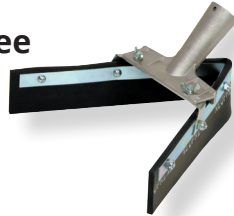

Lightweight U-Crack Filler Squeegee

This squeegee is easy to use and is great for filling cracks prior to applying floor coatings or seal coating material. The replaceable blade has an inside width of 2-1/2". The blade height is 1-1/4".



For crack filler squeegee handle options see page 23.

ITEM #	DESCRIPTION
46002	Lightweight U-Crack Filler Squeegee
SP50121	Replacement Blade (for 46002)
46001	Heavy-Duty U-Crack Filler Squeegee
SP50120	Replacement Blade (for 46001)
46005	Push / Pull V-Crack Filler Squeegee
SP50122	Replacement Blade (for 46005)

Heavy-Duty U-Crack Filler Squeegee

Steel frame with a 5/16" x 2-1/4" neoprene rubber blade. The 9-1/2" deep by 3" U-shaped cavity holds plenty of material. Replacement blades are available.



Foam Squeegees



Double edge foam squeegee with tapered handle adapter. Galvanized steel frame with reinforced handle socket.

ITEM #	DESCRIPTION
47220	Squeegee - Foam Blade, 18"
47222	Squeegee - Foam Blade, 22"
47224	Squeegee - Foam Blade, 30"

Topping and Underlayment "Super Squeegee"

A 24" low-angle / clamp style aluminum frame with a durable aluminum gusset bracing system is combined with a rounded edge, 3" exposed neoprene rubber blade.

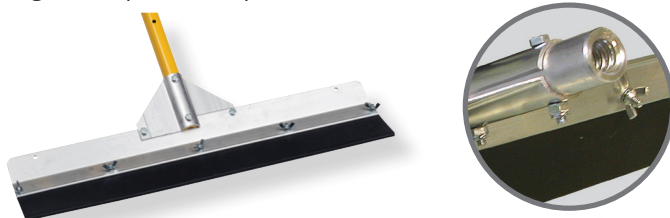

DESCRIPTION	ITEM # / 24"	ITEM # / 36"
Squeegee with Threaded Handle Adapter	78601	78603
Squeegee with 66" Powder-Coated Aluminum Handle	78602	78604
Replacement Blade	SP50071	SP50072

Window Squeegees

Our window squeegees contain a flat non-marking Nitrile blade, superior & less expensive than red rubber. Can be used as a hand-tool or with a tapered wood handle.

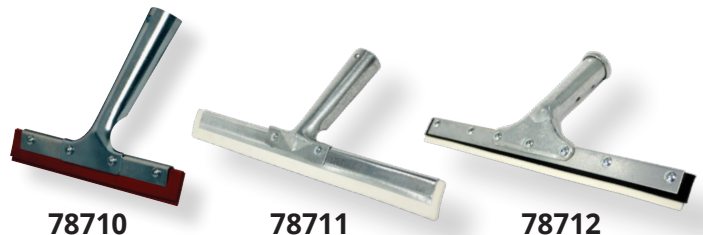

ITEM #	DESCRIPTION
78710	10" Window Squeegee
78711	12" White Window Squeegee
78712	12" White Heavy-Duty Window Squeegee

Wire Gauge Rakes



58624



Radial contact points for a smoother push / pull action

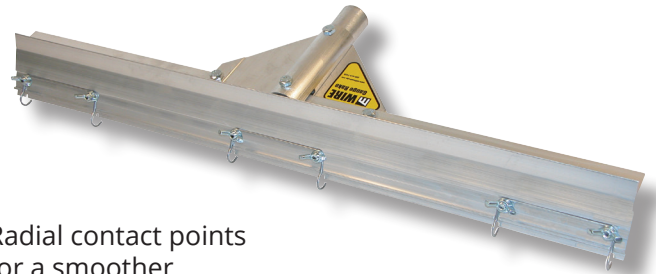

58609

Applies self-leveling floor coatings and lower viscosity materials. Far superior to pin-type gauge rakes on the market. The strong spring-steel wires are formed in a "radial" or loop fashion, eliminating chatter and vibration common with pin-type gauge rakes. Radial contact points will maintain even at varying handle angles and lengths. The adjustable aluminum gate or bar can be set to any desired thickness from 0" to 5/8". Replacement wires are available.

DESCRIPTION	ITEM # / 14"	ITEM # / 24"	ITEM # / 36"
Wire Gauge Rake with Threaded Handle Adapter	58714	58609	58734
Wire Gauge Rake with 66" Powder-Coated Aluminum Handle	-	58624	58736
Wire Gauge Rake with 82" Powder-Coated Aluminum Handle	-	58824	58738
Replacement Wire Set (Set of 3 Wires)	68611	68611	-
Replacement Wire Set (Set of 4 Wires for 36" Width)	68616	-	68616

Sled-Style Gauge Rakes

These self-adjusting gauge rakes have been used by contractors for many years. Although not as precise as our other gauge rakes, they are value priced and will allow you to achieve a reasonably level depth when installing cementitious materials. They also allow you to easily move over rough surfaces. Styles and colors may vary, but the "sled-style" self-adjusting feature of this gauge rake will be a standard characteristic in this category. Our handle adapter is threaded to provide a secure connection.



ITEM #	DESCRIPTION
58420	24" Sled-Style Gauge Rake
58425	36" Sled-Style Gauge Rake
SA30034	Replacement Sleds - Set of 2

GAUGE RAKES - CAM®

CAM® Gauge Rakes

CAM® GAUGE RAKE FRAMES AND CAM® SETS ARE SOLD SEPARATELY

A patented "goof-proof" tool for applying materials at a precise, uniform depth. Ideal for decorative concrete toppings, self-leveling/high-performance coatings, and underlayers. CAM® depth settings range from 1/32" to 1-1/2". Features an aluminum frame with either a threaded adapter or powder-coated handle (sold separately). Choose your frame, handle, and CAM® set. When a contact point wears, loosen the wing nut and rotate the CAM® to a fresh edge. The radial design ensures consistent thickness, even with varying handle angles and lengths.



- Head widths from 10" (hand-held) to 48". CAM® sets in depth settings from 1/32" to 1-1/2".
- The CAM® Gauge Rake is available with a milled threaded handle adapter or a powder-coated aluminum handle. The 10" CAM® Rake is used for small areas and counter tops and has its own fixed handle with grip.



U.S. Patent 5,606,763

MADE IN USA

DESCRIPTION	ITEM # / 10"	ITEM # / 12"	ITEM # / 24"	ITEM # / 36"	ITEM # / 48"
CAM® Gauge Rake, Frame Only, Threaded Handle Adapter		57030	57000	57010	57020
CAM® Gauge Rake, Frame Only, 66" Powder-Coated Aluminum Handle, Frame Only		57031	57001	57011	57021
CAM® Gauge Rake, Frame Only, 82" Powder-Coated Aluminum Handle, Frame Only		57032	57002	57012	57022
CAM® Gauge Rake Frame, Hand-Held Handle w/Grip	57044				

CAM®S SOLD SEPERATELY

CAM® Gauge Rake CAM® Sets



(Two CAM®s Per Set)

ITEM #	ITEM #	ITEM #	ITEM #	ITEM #	ITEM #	ITEM #	ITEM #	ITEM #
1/32" 57078 Size A	1/24" 57079 Size B	1/16" 57081 Size 1	1/8" 57082 Size 2	3/16" 57083 Size 3	1/4" 57084 Size 4	5/16" 57085 Size 5	3/8" 57086 Size 6	1/2" 57088 Size 8
Approx 30 MILs	Approx 42 MILs	Approx 62 MILs	Approx 125 MILs					



ITEM #
57078 - 5 sizes in 1.
1/16", 1/8", 3/16",
1/4" and 5/16"

Looking to apply coatings and slurries at greater than 30 mils? Our smaller CAM® Sets are ideal for Wet Film Thickness from 30 mils to 125 mils.

Larger CAM® Sets

ITEM #	DESCRIPTION
57090	5/8" CAM® Set (2 Each), 3 Settings, Size 10
57096	1" CAM® Set (2 Each), 3 Settings, Size 16
57104	1-1/2" CAM® Set (2 Each), 2 Settings, Size 24

CAM® Sets 3-Packs

ITEM #	DESCRIPTION
57180	CAM® 3-Pack – 1 Set (2 Each), Size 1 (57081), Size 2 (57082) and Size 4 (57084)
57181	CAM® 3-Pack – 1 Set (2 Each), Size 2 (57082), Size 4 (57084) and Size 6 (57086)

Customize Your Own CAM® Gauge Rake or choose from a frame & blade combo (you supply the handle)

Now you can order the exact tool you use most. Supplied with a 24" wide frame and 1 CAM® set. Four different sizes of CAM® sets are available. Simply attach a handle and you have a complete tool. Replacement CAM® sets are available.



ITEM #	DESCRIPTION
57201	24" CAM® Gauge Rake with Size 1 (1/16") CAM® Set (2 Each), THA*
57202	24" CAM® Gauge Rake with Size 2 (1/8") CAM® Set (2 Each), THA*
57203	24" CAM® Gauge Rake with Size 3 (3/16") CAM® Set (2 Each), THA*
57204	24" CAM® Gauge Rake with Size 4 (1/4") CAM® Set (2 Each), THA*
57206	24" CAM® Gauge Rake with Size 6 (3/8") CAM® Set (2 Each), THA*

*Threaded Handle Adapter



Key Product Feature

We use a "radial" edge CAM® design which maintains uniform coating thickness, even at varying handle angles and lengths.

NEW

STEEL NOTCHED RAKES

ON-DEMAND CONSISTENCY & CONTROL

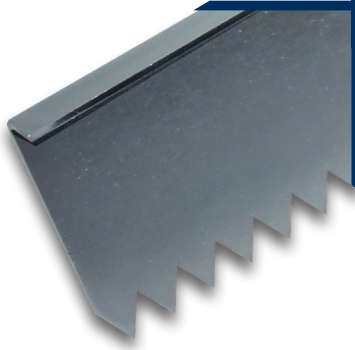

FEATURES & BENEFITS:

- Available in five precision notch sizes: 1/8", 3/16", 1/4", 3/8", and 1/2".
- Delivers uniform material thickness across urethane cement and epoxy systems.
- Ideal for slurry-down applications - rake, spike, and walk away.
- Produces consistent, repeatable results job after job.
- Zinc-plated construction resists corrosion and simplifies cleanup.
- Heavy-duty carbon steel edge handles aggregate without premature wear.

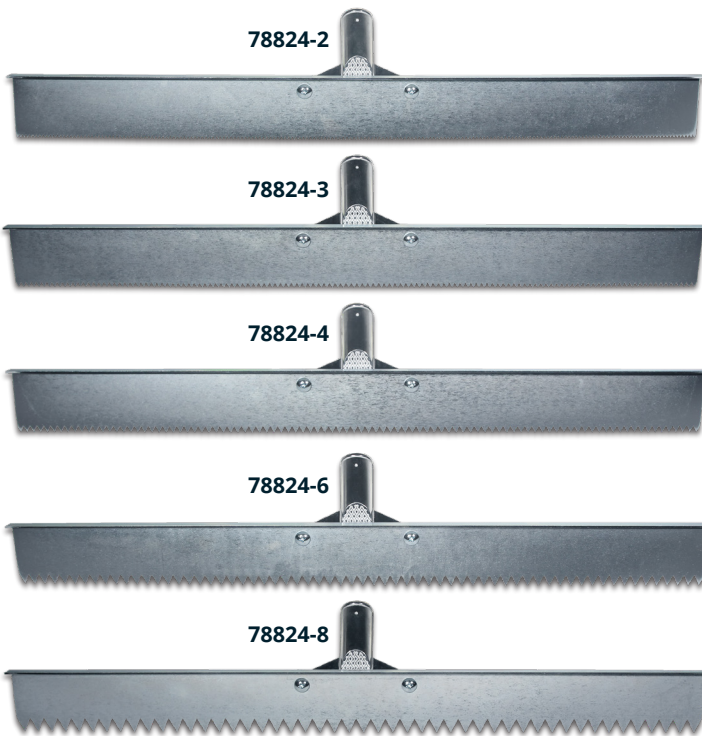

**THREADED
HANDLE
ADAPTER**



**ZINC-
PLATED
CONSTRUCTION**



**CARBON
STEEL
EDGE**

The Midwest Rake Steel Notched Rake is built for contractors who demand consistent mil thickness and flawless material control when installing urethane cement systems, slurries, and self-leveling epoxies.

The 24" laser-cut carbon steel bar features precision V-profile notches to deliver uniform coverage on every pass. The angled threaded handle adapter connection maintains a true 90° working angle, keeping material depth consistent across the floor.

Each rake is manufactured to a fixed notch height, eliminating setup guesswork: simply select your notch

size and start pulling. The rugged zinc-plated aluminum bracket installs tool-free using a carriage bolt and wing nut for fast adjustments on site. The abrasion-resistant stainless edge stands up to heavy aggregate while remaining easy to clean between pours.

ITEM #	DESCRIPTION
78824-2	24" Steel Notched Rake - 1/8", Zinc Plated with Aluminum Threaded Handle Adapter
78824-3	24" Steel Notched Rake - 3/16", Zinc Plated with Aluminum Threaded Handle Adapter
78824-4	24" Steel Notched Rake - 1/4", Zinc Plated with Aluminum Threaded Handle Adapter
78824-6	24" Steel Notched Rake - 3/8", Zinc Plated with Aluminum Threaded Handle Adapter
78824-8	24" Steel Notched Rake - 1/2", Zinc Plated with Aluminum Threaded Handle Adapter

TROWELS & SMOOTHERS

**NEW &
IMPROVED**

Ultimate Trowel®



- **BLADE SHEATH PROVIDED TO PROTECT THE BLADE & EXTEND LIFE OF TOOL**
- **COMFORT HAND GRIP WITH THREADED HANDLE ADAPTER**



**MATERIAL SCIENCE PROVIDES
A MORE DURABLE BLADE FOR
LONGER TOOL LIFE**

This style of trowel has been a contractor favorite to smooth the surface of applied cementitious overlays, particularly overlays of a more fluid consistency. A very effective finishing tool capable of creating a flawless surface. Blade has a slipcoat layer that provides an easy to clean surface.

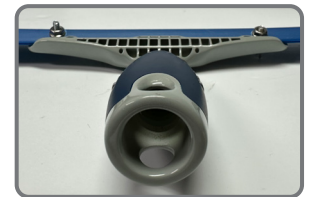

ITEM #	DESCRIPTION	PACK QTY
47420-12	12" Ultimate Trowel® with THA	12
47420-18	18" Ultimate Trowel® with THA	12
47420-22	22" Ultimate Trowel® with THA	12

ITEM #	DESCRIPTION	PACK QTY
47420-24	24" Ultimate Trowel® with THA	12
47420-26	26" Ultimate Trowel® with THA	12

The Midwest Trowel

The Midwest Trowel is used to smooth the surface of applied cementitious overlays, particularly overlays of a more fluid consistency.



Performs identical to the Original Magic Trowel®

ITEM #	DESCRIPTION	PACK QTY
47415	12" Midwest Trowel with THA	1
47416	18" Midwest Trowel with THA	1
47417	22" Midwest Trowel with THA	1
47418	24" Midwest Trowel with THA	1
47419	26" Midwest Trowel with THA	1

Flexible Blade Smoother

This flexible 24" x 5" rounded corner steel blade is bent and angled to maximize blade contact with a range of surface coating materials. This smoothing tool can also serve as a spreading tool and even a surface preparation tool. It is most often used when troweling and / or smoothing overlay / underlay material (toppings) of a cementitious composition. The blade is contained in a durable aluminum frame with our superior aluminum gusset bracing system. This tool is available with a threaded handle adapter or with a 66" powder-coated aluminum handle.

Rounded Corner

ITEM #	DESCRIPTION	BLADE SIZE
78906	With Threaded Handle Adapter	24"
78907	With 66" Powder-Coated Aluminum Handle	24"



Square Corner

ITEM #	DESCRIPTION	BLADE SIZE
78902	With Threaded Handle Adapter	24"
78903	With 66" Powder-Coated Aluminum Handle	24"



TROWELS, SCRAPERS, SMOOTHERS/SPREADERS

Heavy-Duty Cove Trowels

6" and 8" Wall Height Regulation Compliant

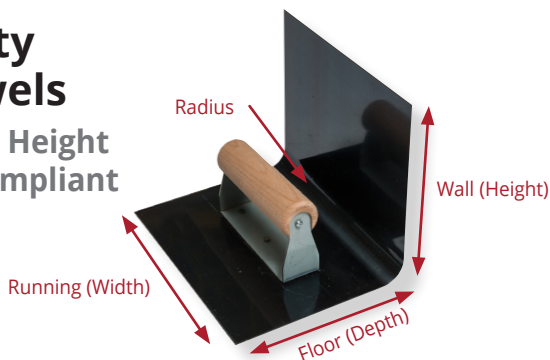

ITEM #	DESCRIPTION
47481	3/4" Radius, 6" Wall (H) x 5-3/4" Floor (D) x 7-1/2" Running (W)
47482	3/4" Radius, 8" Wall (H) x 5-3/4" Floor (D) x 7-1/2" Running (W)
47485	1" Radius, 6" Wall (H) x 5-3/4" Floor (D) x 7-1/2" Running (W)
47486	1" Radius, 8" Wall (H) x 5-3/4" Floor (D) x 7-1/2" Running (W)

Standard Cove Trowels

High Carbon Blue Steel



ITEM #	DESCRIPTION
47414	Heavy-Duty 1" Radius, 3.5" H x 5-3/4" D x 7-1/2" W
47409	Heavy-Duty 3/4" Radius, 3.5" H x 5-3/4" D x 7-1/2" W
47411	Economy Regular 1" Radius, 3" H x 4" D x 6" W
47412	Economy Regular 1" Radius, 3" H x 6" D x 6" W

Tempered, ground and polished high-carbon spring steel trowels. Blades are fastened with hardened steel ground rivets. Wooden handles for better gripping power. Selected by manufacturers' "technical specialists" for decorative concrete and floor coating applications.



Rounded End Trowels



ITEM #	SIZE
47465	4" x 16"
47466	4" x 18"
47475	3" x 12"
47477	3" x 16"

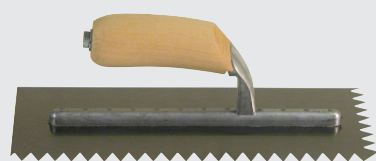

Notched Trowels

11" x 4-1/2" Overall

ITEM #	SIZE
47406	3/16" V-Notch
47403	1/4" V-Notch
47402	1/2" V-Notch



"Spring Form" Trowels

Shorter Rib,
More Flexibility

ITEM #	SIZE
47470	Square Edge, 5" x 16"
47468	Rounded Edge, 5" x 16"

Epoxy Mortar Trowels



ITEM #	SIZE
47460	3" x 12"
47461	3" x 16"



Finishing Trowels

ITEM #	SIZE
47404	4" x 12"
47405	4" x 16"

Scrapers

The 16 gauge stainless steel blade, available in widths of 8", 12" and 16", is attached to our super-strong, unique and durable overlapping gusset bracing system along with a 66" powder-coated aluminum handle. This is one of the most powerful scrapers on the market. The blade can be sharpened for project needs.

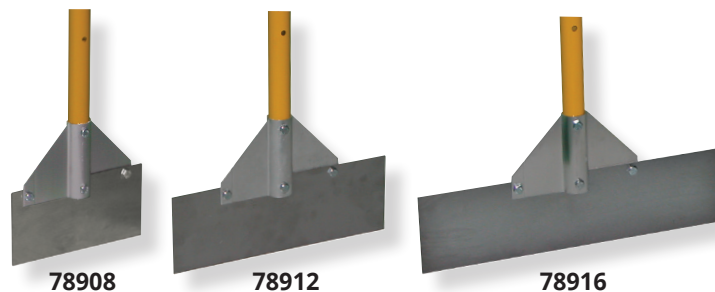

DESCRIPTION	ITEM # / 8"	ITEM # / 12"	ITEM # / 16"
Stainless Steel Scraper	78908	78912	78916
Replacement Blade	SP50027	SP50028	SP50029

Smoother/Spreader

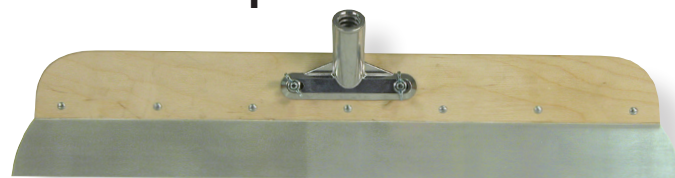

ITEM #	DESCRIPTION
78930	Wood / Steel Smoother with 22" Frame and 23-1/2" x 2" Heat-Treated Fan-Shaped Blade, THA*

*Threaded Handle Adapter

SPIKED ROLLER

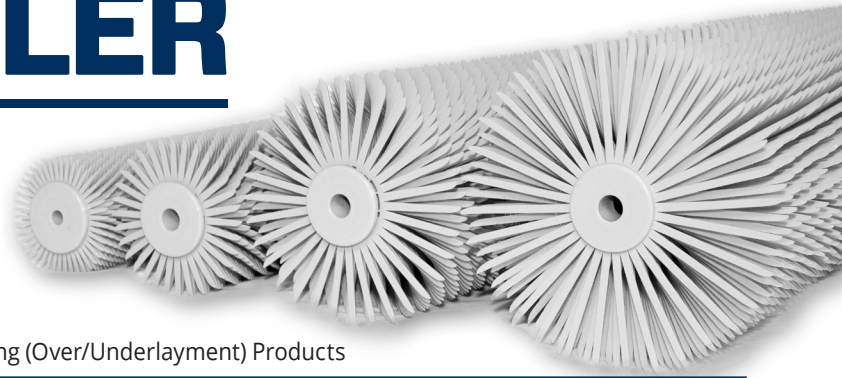

- 5 Tine Lengths Available: 1/2", 13/16", 1-1/4", 1-1/2" & 2"
- Abrasion-Resistant Nylon Tines Provide Superior Tool Life
- Dense Configuration of Tin-Plated Steel Tines
- 3/8" End-Caps Allow Use with Midwest Rake® 9" Radial Frame, Medium-Duty Frame or Heavy-Duty Aluminum Frame
- Designed for Maximum Effectiveness in Releasing Entrapped Air and Promoting Self-Leveling of Coatings
- Engineered to Improve the Application Characteristics of Resurfacing (Over/Underlayment) Products

RADIAL FRAME



59010	9" Radial Frame
-------	-----------------

REPLACEMENT PARTS

59019	Hardware Bag for 9" Radial Frame (Washers / Spring Clip)
-------	--

Choose Your Frame:

MEDIUM-DUTY FRAME



59030	18" Medium-Duty Aluminum Frame
59050	24" Medium-Duty Aluminum Frame
59070	36" Medium-Duty Aluminum Frame

REPLACEMENT PARTS

59089	Hardware Bag for 18" & 24" & 36" Medium-Duty Aluminum Frames
59091	Threaded Handle Adapter & Screw for Medium-Duty Frame

HEAVY-DUTY FRAME



60115	36" Heavy-Duty Aluminum Frame with Threaded Handle Adapter
60116	36" Heavy-Duty Aluminum Frame with 66" Powder Coated Aluminum Handle
60110	18" Heavy-Duty Aluminum Frame with Threaded Handle Adapter
60112	18" Heavy-Duty Aluminum Frame with 66" Powder Coated Aluminum Handle
60113	24" Heavy-Duty Aluminum Frame with Threaded Handle Adapter
60114	24" Heavy-Duty Aluminum Frame with 66" Powder Coated Aluminum Handle

Choose Your Roller:

	Item No.	Description
NYLON	59011	9" Spiked Roller, 1/2" Supersharpest Tines
	59031	18" Spiked Roller, 1/2" Supersharpest Tines
	59051	24" Spiked Roller, 1/2" Supersharpest Tines
	59071	36" Spiked Roller, 1/2" Supersharpest Tines

Ideal for Resinous Coatings (Epoxy & Urethane)

	Item No.	Description
NYLON	59012	9" Spiked Roller, 13/16" Supersharpest Tines
	59032	18" Spiked Roller, 13/16" Supersharpest Tines
	59052	24" Spiked Roller, 13/16" Supersharpest Tines
	59072	36" Spiked Roller, 13/16" Supersharpest Tines

Ideal for Cementitious and Gypsum Resurfacing Materials

	Item No.	Description
METAL	48090	9" Metal-Tined Roller, 1/2" Tines
	48091	18" Metal-Tined Roller, 1/2" Tines
	48092	24" Metal-Tined Roller, 1/2" Tines

	Item No.	Description
NYLON	59013	9" Spiked Roller, 1-1/2" Supersharpest Tines
	59033	18" Spiked Roller, 1-1/2" Supersharpest Tines
	59053	24" Spiked Roller, 1-1/2" Supersharpest Tines
	59073	36" Spiked Roller, 1-1/2" Supersharpest Tines

Ideal for Cementitious and Gypsum Resurfacing Materials

	Item No.	Description
NYLON	59014	9" Spiked Roller, 2" Supersharpest Tines
	59034	18" Spiked Roller, 2" Supersharpest Tines
	59054	24" Spiked Roller, 2" Supersharpest Tines
	59074	36" Spiked Roller, 2" Supersharpest Tines

Ideal for Cementitious and Gypsum Resurfacing Materials
2" Nylon Spiked Rollers Can Only Be Used with the 9" Radial Frame or the Medium-Duty Frames

	Item No.	Description
METAL	48093	9" Metal-Tined Roller, 1-1/4" Tines
	48094	18" Metal-Tined Roller, 1-1/4" Tines
	48095	24" Metal-Tined Roller, 1-1/4" Tines

Metal-Tined Spiked Roller Covers

Midwest Rake® spiked rollers are engineered for superior performance, reducing out-gassing and promoting leveling in resinous coatings and resurfacing materials. Featuring a dense steel tine design inspired by the classic 'porcupine' roller, these rollers include a 1-1/2" aluminum core and 3/8" black end caps. Ideal for cementitious and gypsum overlays, they enhance self-leveling and minimize out-gassing.

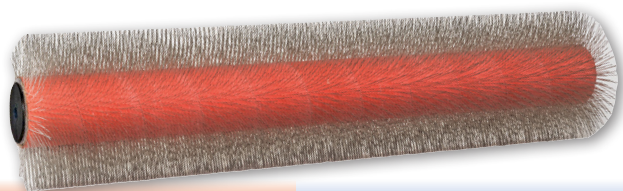

Ribbed Rollers

Ribbed rollers are used to evenly distribute resin and other bonding materials when installing fiberglass and other high performance fabric and mesh laminate reinforcement systems. The use of these rollers enhances the fiberglass / fabric saturation and containment, while removing air bubbles and pockets. These rollers are useful in the installation of tank linings, concrete secondary containment systems and concrete mortar laminate reinforcement flooring applications. Aluminum rollers are the industry standard. All styles have fins designed with just enough angle to increase strength without sacrificing air relief. These rollers are designed to reduce sheared fiber by insuring a radius is machined on each fin. Resin can be burned off with a torch.

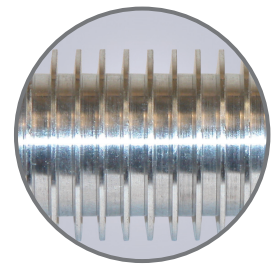

Replaceable Sleeve Ribbed Rollers

These aluminum rollers fit directly on standard paint roller frames. They have a 2" diameter with a 1-1/2" diameter center to slip over paint roller frames just like a paint roller cover. The rollers are made from strong 6063 aluminum and are machined to exacting standards of the 2" aluminum rollers shown below. They are sold as complete tools, with replacement sleeves available.

ITEM #	DESCRIPTION
48304	4" x 2" Aluminum Ribbed Roller Replacement Sleeve, 1-1/2" Inside Diameter - Use with 48404 Roller Frame
48309	9" x 2" Aluminum Ribbed Roller Replacement Sleeve, 1-1/2" Inside Diameter - Use with 48540, 48403, & 48400 Roller Frames
48318	18" x 2" Aluminum Ribbed Roller Sleeve, 1-1/2" Inside Diameter - Use with 48410 & 48418 Roller Frames

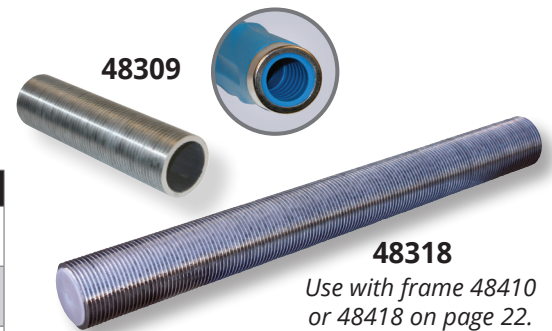

Ribbed Rollers with Wooden Handles

These aluminum rollers have a traditional deep fin, straight groove design. Machined radius fin corners reduce glass fiber shearing. They have reduced clearance for less resin contamination. These rollers come on strong galvanized steel frames with undersized handle bore for a tight fit and long life. The wood handles are steel ferruled and accept standard threaded extension handles (see page 23).

ITEM #	DESCRIPTION
48313	3" Aluminum Ribbed Roller, 1" Diameter, Wood Handle - Complete Tool
48316	6" Aluminum Ribbed Roller, 1" Diameter, Wood Handle - Complete Tool
48326	6" Aluminum Ribbed Roller, 2" Diameter, Wood Handle - Complete Tool
48329	9" Aluminum Ribbed Roller, 2" Diameter, Wood Handle - Complete Tool

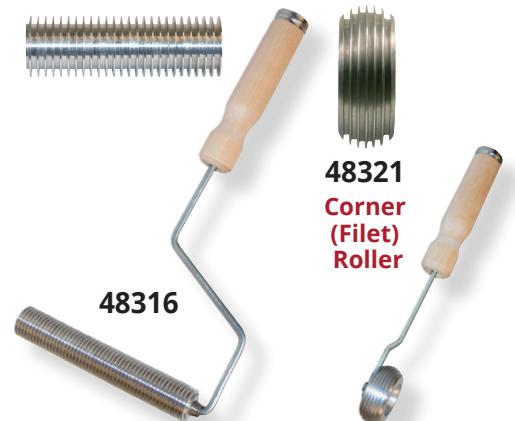

Specialty Ribbed Rollers

These specialty rollers are designed for concave surfaces and filets where flat rollers are not effective. All of these rollers come with strong steel frames and ferrule reinforced wood handles with handle adapters that accept standard extension handles (see page 23 for handles). All of these rollers are machined with the deepest fins possible for efficient air relief and excellent lay up properties.

ITEM #	DESCRIPTION
48321	3/4" Aluminum Corner (Filet) Ribbed Roller, 2-1/2" Diameter - Complete Tool
48323	3" Aluminum (Barrel) Radius Ribbed Roller, 2" Diameter - Complete Tool
48310	3" Aluminum Inverted Radius Ribbed Roller, 1" Diameter - Complete Tool



Fiberglass Scissors

These 10" knife-edge fiberglass scissors are very rigid and American Made. The knife edge design insures clean, crisp shearing action for all fiberglass materials. The increased blade angle of 45° over the 15° angle of standard scissors reduces effort and leaves a cleaner, more even cut.



48300



MIDWEST RAKE® ASSURANCE®

GUARANTEED QUALITY AND CONSISTENCY

GUARANTEED QUALITY & CONSISTENCY FOR THE EPOXY FLOORING CONTRACTOR

Assurance® covers are designed to meet the needs of flooring contractors. They are extremely shed-resistant and provide a consistent quality you can depend on.

KEY FEATURES OF WOVEN:

- Premium quality high density fabric
- Solvent resistant phenolic core
- Designed for use with epoxies and urethanes of all types



ITEM #	DESCRIPTION	PACK QTY
48201	4" Assurance® Woven Shed-Resistant Roller Cover - 3/8" Nap	12
48202	9" Assurance® Woven Shed-Resistant Roller Cover - 1/4" Nap	12
48203	9" Assurance® Woven Shed-Resistant Roller Cover - 3/8" Nap	12
48204	9" Assurance® Woven Shed-Resistant Roller Cover - 1/2" Nap	12
48208	18" Assurance® Woven Shed-Resistant Roller Cover - 1/4" Nap	6
48209	18" Assurance® Woven Shed-Resistant Roller Cover - 3/8" Nap	6

ITEM #	DESCRIPTION	PACK QTY
48210	18" Assurance® Woven Shed-Resistant Roller Cover - 1/2" Nap	6
48040	24" Pro-Grade Woven Shed-Resistant Roller Cover - 3/8" Nap	6
48042	24" Pro-Grade Woven Shed-Resistant Roller Cover - 1/2" Nap	6
48050	36" Pro-Grade Woven Shed-Resistant Roller Cover - 3/8" Nap	6
48052	36" Pro-Grade Woven Shed-Resistant Roller Cover - 1/2" Nap	6

All 18" covers fit 1/4" axles and come with 1/4" (white) end caps. All 24" & 36" covers fit 3/8" axles and come with black 3/8" end caps. See Roller Frame options on pages 21-22.

KEY FEATURES OF PHENOLIC:

- Solvent Resistant
- Spreading and leveling of applied epoxies and mastics, anti-slip floor coverings and heavier coatings

KEY FEATURES OF LOOPED:

- Ideal for applying cement urethanes
- Often used with aggregated coatings
- Great for spreading and back-rolling

Specialty Roller Covers

ITEM #	DESCRIPTION	PACK QTY
48015	9" Assurance® Looped Polymer Roller Cover, No End Caps	12
48018	18" Assurance® Looped Polymer Roller Cover, 1/4" End Caps	6
48025	9" Phenolic Roller Cover, No End Caps	12
48019	18" Phenolic Roller Cover, 1/4" End Caps	6



ROLLER COVERS, ROLLERS & FRAMES



ITEM #	DESCRIPTION	PACK QTY
48441	9" Painter's Solution™ Roller Cover - 3/16" Nap	12
48447	18" Painter's Solution™ Roller Cover - 3/16" Nap	6
48443	9" Painter's Solution™ Roller Cover - 3/8" Nap	12
48449	18" Painter's Solution™ Roller Cover - 3/8" Nap	6
48444	9" Painter's Solution™ Roller Cover - 1/2" Nap	12
48450	18" Painter's Solution™ Roller Cover - 1/2" Nap	6



ITEM #	DESCRIPTION	PACK QTY
48485	9" American Contractor® Knit Cover - 3/8" Nap	12
48481	18" American Contractor® Knit Cover - 3/8" Nap	6
48520	9" Economy Knit Cover - 3/8" Nap	100
48521	9" Economy Knit Cover - 1/2" Nap	100
48522	9" Economy Knit Cover - 3/4" Nap	100



ITEM #	DESCRIPTION	PACK QTY
48414	9" Microplush™ Roller Cover - 5/16" Nap	12
48415	18" Microplush™ Roller Cover - 5/16" Nap	6



ITEM #	DESCRIPTION	PACK QTY
48430	9" Epoxy Glide™ Roller Cover - 1/4" Nap	12
48431	18" Epoxy Glide™ Roller Cover - 1/4" Nap	6



ITEM #	DESCRIPTION	PACK QTY
48491	4" Super Doo-Z® 3/8" Nap	12
48490	4" Super Doo-Z® 1/2" Nap	12
48423	9" Pro/Doo-Z® Roller Cover - 3/8" Nap	12
48424	18" Pro/Doo-Z® Roller Cover - 3/8" Nap	6
48426	9" Pro/Doo-Z® Roller Cover - 1/2" Nap	12
48428	18" Pro/Doo-Z® Roller Cover - 1/2" Nap	6



ITEM #	DESCRIPTION	PACK QTY
48419	9" Mohair Blend™ Roller Cover - 1/4" Nap	12
48420	18" Mohair Blend™ Roller Cover - 1/4" Nap	6

4" Frames



ITEM #	DESCRIPTION	PACK QTY
48004	4" Sherlock® Frame	6
48404	4" Acme™ Heavy-Duty Frame	24



Mini-Koter® and Frames

ITEM #	DESCRIPTION	PACK QTY
48407	Mini-Koter® Frame, 12" Length	12
48411	Sherlock® Mini Pro Frame (Long Handle)	12
48476	6" Mini-Koter® Woven 3/8" 2 pack	12
48477	6" Mini-Koter® Woven 3/8" 10 pack	1
48478	6" Mini-Koter® Knit 1/2" 2 pack	12
48479	6" Mini-Koter® Knit 1/2" 10 pack	1
48473	4" Mini-Koter® Woven 3/8" 2 pack	12
48474	4" Mini-Koter® Woven 3/8" 10 pack	1
48452	4" Mini-Koter® Knit 1/2" 2 pack	12
48453	4" Mini-Koter® Knit 1/2" 10 pack	1



ROLLER FRAMES & ACCESSORIES

Roller Frames

48400: Quick-release spring prevents roller slippage; smooth bearings for reliability; polypropylene grip; threaded handle adapter. A top universal roller frame. **48403:** Traditional paint roller frame with threaded handle adapter. **48507:** Heavy-duty aluminum yoke frame; threaded handle; 1/4" pins; adjustable 12"-18"; wingnuts lock frame; includes small bore end caps for 1/4" pins. **48410:** Adjustable steel frame fits 9"-18" covers; rigid yet lightweight (<1 lb); threaded handle adapter. **48418:** Lightweight, durable polypropylene 18" non-adjustable frame; fits all 18" covers; threaded handle adapter; replaceable fiberglass-reinforced nylon legs.



Item #	DESCRIPTION	PACK QTY
48400	9" Wooster® Sherlock® Frame	6
48403	9" Wooster® Magikage® Ninety Frame	12
48540	9" Wooster® Acme™ Heavy-Duty Roller Frame	24
48507	12" - 18" Industrial Adjustable Roller Frame	6
48410	Wooster® Sherlock Wide Boy™ 18" Frame	3
48418	Wooster® Big Ben® 18" Frame	10
SA30006	Replacement Nylon Legs for 48418 - Set of 2	6

NEW Microfiber Pad System

Microfiber penetrates pores to remove fine dust. Velcro backing allows quick head changes. Note: 48580 handle is unique and only fits 48581-18 & 48581-24 frames.

ITEM #	DESCRIPTION	PACK QTY
48503-18	18" Microfiber Pad - 5" wide	12
48503-24	24" Microfiber Pad - 5" wide	12
48581-18	Frame for 18" Microfiber Pad	6
48581-24	Frame for 24" Microfiber Pad	6
48580	37.25" - 60" Telescopic Pole For Microfiber Pad System	12

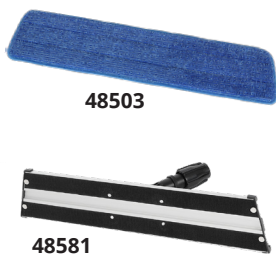

48580

NEW T-Bar System

Professional-grade frame in 12" and 18" sizes. Features a 180° pivoting head, 1" steel tube for easy pad changes, and threaded adapter for standard poles. Includes 1" foam refill pads with specially finished fabric.

ITEM #	DESCRIPTION	PACK QTY
48235-12	12" Lightweight T-Bar	6
48235-18	18" Lightweight T-Bar	6
48236-12	12" Foam T-Bar Refill	12
48236-18	18" Foam T-Bar Refill	12



Paint Trays & Accessories

ITEM #	DESCRIPTION	PACK QTY
48466	Big Ben® Tray - 1 Gallon Capacity	6
48470	Big Ben® Tray Liner	12
48493	Deluxe Metal Tray	12
48494	Deluxe Metal Tray Liner	48
48530	Acme™ Deluxe 5-Gallon Grid	12



Wide Boy™ Bucket & Liners

- 14" x 24" x 10"
- Built-in 19" wide roll-off area
- Comfort grip for moving when filled
- Durable, seamless, green polypropylene
- No tip design & heavy-duty 5/16" galvanized bail

ITEM #	DESCRIPTION	PACK QTY
48467	Sherlock® Wide Boy™ Bucket with Handle - 5 Gallon	3
48468	Quick N Clean™ Wide Boy™ Liner - 5-pk	12



POLES & EXTENSION HANDLES

Extension Handle Options

Powder-coated aluminum handles with milled aluminum threaded tips - for use with threaded handle adapters.

Our milled threaded tip handles provide the tightest fit with tools using our exclusive threaded adapter. Each handle features a durable, milled aluminum tip for added strength—no more broken tips—and comes in 60", 66", and 82" lengths. A 60" extension handle is also available, with a threaded aluminum tip on one end and a threaded receptacle on the other.

Hardwood Handles - We offer a variety of high quality hardwood handles, with either a tapered tip or a metal threaded tip.



ITEM #	DESCRIPTION		PACK QTY
A. SA20173	60" PCGAH* Handle with Aluminum Threaded Tip	NEW	1
B. SA20174	66" PCGAH* Handle with Aluminum Threaded Tip	NEW	1
C. SA20175	82" PCGAH* Handle with Aluminum Threaded Tip	NEW	1
D. SA20228	60" PCGAH* Extension Handle, Threaded Tip and Socket	NEW	1
E. SP20220	1-1/8" x 60" Hardwood Handle, Tapered Tip		1
F. SP20221	1-1/8" x 72" Hardwood Handle, Tapered Tip		1
G. SP20215	15/16" x 60" Hardwood Handle, Metal Threaded Tip		1
H. SP20216	15/16" x 72" Hardwood Handle, Metal Threaded Tip		1
I. 60320	60", 3 Piece Aluminum Handle, Threaded Handle Adapter		1

*Powder-Coated Gray Aluminum Handle

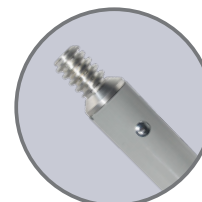

A. / B. / C.

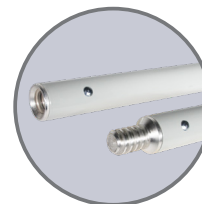

D.



E. / F.



G. / H.



I.

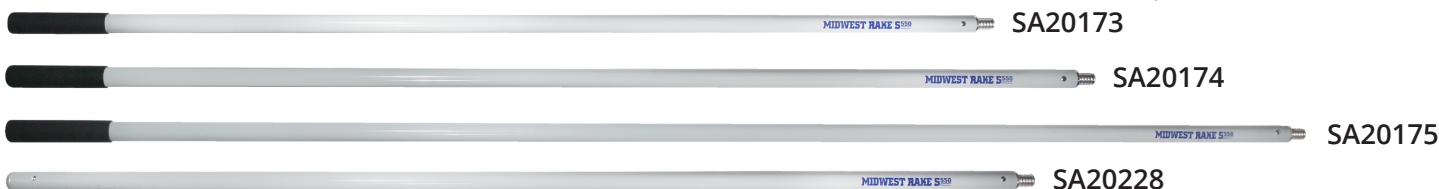

Fiberglass Extension Handles - Prized by painting contractors, cleaning professionals and other users who look for extended reach with maximum adjustability, our extension handles have been top-sellers for decades. Our patented STÅ-LOK® mechanism is the most convenient and reliable to use. Just twist to lock in any position.

Sherlock® Extension Poles

ITEM #	DESCRIPTION	PACK QTY
SP20207	Sherlock® 2' - 4' Extension Pole	6
SP20208	Sherlock® 4' - 8' Extension Pole	6
SP20209	Sherlock® 6' - 12' Extension Pole	3
SP20217	Sherlock GT® Convertible™ 2'-4' Pole	NEW 6
SP20218	Sherlock GT® Convertible™ 4'-8' Pole	NEW 6
SP20219	Sherlock GT® Convertible™ 6'-12' Pole	NEW 3



Structron® Superhandle® Extension Handle

- Threaded #5 Acme aluminum tip
- Fiberglass telescoping handle with collar lock, cushion grip
- Threaded tip replacement kit (60259)

ITEM #	DESCRIPTION	PACK QTY
60245	Structron® 2' - 4' Handle	6
60244	Structron® 3' - 6' Handle	6
60246	Structron® 4' - 8' Handle	6
60247	Structron® 6' - 12' Handle	6
60248	Structron® 8' - 16' Handle	6

Structron® Straight Extension Handle

- Ultra tip milled from solid aluminum bar with fiberglass handle and 7" double dip grip (60280-60282)
- Threaded #5 Acme aluminum tip with fiberglass handle with vinyl end cap (60240-60242)
- Threaded tip replacement kits (60259 & 60279)

ITEM #	DESCRIPTION	PACK QTY
60280	Structron® 1" x 48" Handle, Ultra tip	6
60281	Structron® 1" x 60" Handle, Ultra tip	6
60282	Structron® 1" x 72" Handle, Ultra tip	6
60240	Structron® 1" x 48" Handle	6
60241	Structron® 1" x 60" Handle	6
60242	Structron® 1" x 72" Handle	6



MISCELLANEOUS TOOLS

Low Viscosity Mixers

Pro-Grade mixers are the choice of many contractors. These mixers have low shear for minimal air entrapment while mixing. Our Pro-Grade mixer is constructed of quality powder-coated steel and available in a 2-5 gallon paddle with a 4-3/4" turbine style head on a 23-1/2" x 3/8" diameter hex shaft.

Jiffy Style Mixers are also available in two sizes; a 1-2 gallon and a 2-5 gallon. They are made of 304 stainless steel and fit all 1/4" - 3/4" chucked power tools. The blade actions are characterized by a smooth, thorough, non-air sucking and non-splashing action.

ITEM #	DESCRIPTION	PACK QTY
47444	Large Pro-Grade Low Viscosity Mixing Paddle, 2-5 Gallon	1
47432	Jiffy Style Mixer Blade, 1-2 Gallons	1
47434	Jiffy Style Mixer Blade, 2-5 Gallons	1
47431	1 Gallon Helix Mixer	1
47433	5 Gallon Helix Mixer	1
47436	2-3/8" x 17" Paint Mixer	1
47439	4" x 30" Paint Mixer	1



High Viscosity Mixing Paddles

These mixers are used by those in the decorative concrete, and stamping markets. The "football" shaped cage configurations are ideal for mixing more viscous "topping" and cementitious materials. The larger 10" x 6" head is designed for barrel mixing.

ITEM #	DESCRIPTION	PACK QTY
47425	Large High Viscosity Oval Mixing Paddle - 26" Shaft	1
47426	Large High Viscosity Oval Mixing Paddle - 36" Shaft	1
47428	Box Mixer, 5" Diameter, 7/16" x 30" Shaft	1
47429	Box Mixer, 5" Diameter, 7/16" x 23" Hex Shaft	1

Chip Brushes

Chip brushes are ideal for flooring and protective and marine contractors who require a disposable and inexpensive brush to trim in around corners and edges.

ITEM #	DESCRIPTION	PACK QTY
48130	1" White Bristle Chip Brush	36
48131	2" White Bristle Chip Brush	24
48132	2-1/2" White Bristle Chip Brush	12
48133	3" White Bristle Chip Brush	12
48134	4" White Bristle Chip Brush	12
48142	2-1/2" White Bristle Double Thick Chip Brush	12
48143	3" White Bristle Double Thick Chip Brush	12
48144	4" White Bristle Double Thick Chip Brush	12
48459	1" Solvent-Proof Chip Brush	36
48460	1-1/2" Solvent-Proof Chip Brush	24
48461	2" Solvent-Proof Chip Brush	24
48462	2-1/2" Solvent-Proof Chip Brush	24



48463	3" Solvent-Proof Chip Brush	24
48464	4" Solvent-Proof Chip Brush	6
48561	2" Factory Sale Gray Bristle Brush	24
48563	3" Factory Sale Gray Bristle Brush	12
48564	4" Factory Sale Gray Bristle Brush	12

Solvent-Resistant Gloves

These nitrile, flock-lined, form fitting gloves are resistant to solvents used regularly within the coating industry.

ITEM #	DESCRIPTION	PACK QTY
46209	Solvent-Resistant Gloves (Pair) - Large	12
46210	Solvent-Resistant Gloves (Pair) - Extra Large	12
46211	Solvent-Resistant Gloves (Pair) - 2XL	12



46209



46216

Disposable Nitrile Gloves

Powder free disposable nitrile gloves come 100 per box.

ITEM #	DESCRIPTION	PACK QTY
46216	Heavyweight Nitrile Gloves, 5 MIL - Medium	1
46212	Heavyweight Nitrile Gloves, 5 MIL - Large	1
46213	Heavyweight Nitrile Gloves, 5 MIL - Extra Large	1



46217



46219

Recycled White Cotton Knitcloth

ITEM #	DESCRIPTION	PACK QTY
46217	4 LB #5 Block Recycled White Cotton Knitcloth	1

Non-Skid Shoe Covers

ITEM #	DESCRIPTION	PACK QTY
46219	Blue Non-Skid Shoe Covers - 10 Pair Per Pack	1

2" Floor Masking Tape

Durable, moisture resistant sealing tape with a synthetic rubber-based pressure-sensitive adhesive. This tape is designed to adhere to a variety of surfaces and otherwise difficult-to-bond materials.

ITEM #	DESCRIPTION	PACK QTY
46218	PE35 2" Red Polyethylene Tape NEW	24
46220	AC-47 2" Red Duct Tape NEW	24



46218



46220

Mixing Containers

ITEM #	DESCRIPTION	PACK QTY
46221	1 Quart Mix & Measure Container	50
46223	2-1/2 Quart Mix & Measure Container	50
46225	5 Quart Mix & Measure Container	50
46228	5 Gallon Project Bucket - Blue	1
46229	5 Gallon Natural Mix & Measure Bucket	1
46230	10 Quart Mix & Measure Container	12
46235	5 Liter Mixing Pitcher with Handle	1



46223

46228

46221

46223

46225

46230

BROOMS, PEGS & KITS

Duo Broom Best for the removal of “fine” materials because of its combination of strong 3” polypropylene bristles with an added layer of outside bristles. Features our super-strong, unique and durable overlapping gusset bracing system.

ITEM #	DESCRIPTION
82904	Seymour® S500 Industrial™ 24" Duo Broom, 60" Ergonomic Blue Powder-Coated Aluminum Handle
82906	Seymour® S500 Industrial™ 36" Duo Broom, 60" Ergonomic Blue Powder-Coated Aluminum Handle



Sealing Brush Heavy-duty sealing brush with 2.5" Flexible poly bristles, solid aluminum gusset bracing, and aluminum handle.

ITEM #	DESCRIPTION
77036	Midwest Rake® S550 Professional™ 36" Heavy-Duty Sealing Brush, 2.5" Flexible Poly Bristle with 66" Yellow Aluminum Handle
SP50039	Replacement Head for 77036 Heavy-Duty Sealing Brush

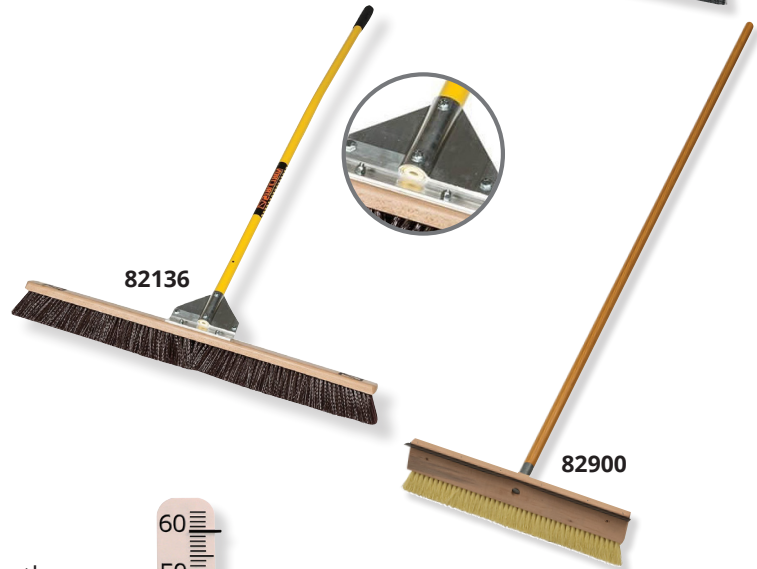

General Purpose Broom Features our super-strong, unique and durable overlapping gusset bracing system.

ITEM #	DESCRIPTION
82124	Structron® S600 Power™ 24" General Purpose Broom, 60" Ergonomic Yellow Powder-Coated Aluminum Handle
82136	Structron® S600 Power™ 36" General Purpose Broom, 60" Ergonomic Yellow Powder-Coated Aluminum Handle

Protective Coating Brush Polypropylene bristles plus a squeegee blade make this an ideal protective coating application tool.

ITEM #	DESCRIPTION
82900	Midwest Rake® 18" Coating Brush with Squeegee, 60" x 15/16" Metal Threaded Tip Wood Handle
47240	18" Protective Coating Brush with Squeegee Blade (Head Only)

Stick-Ems™ Level Pegs

Stick-Ems™ Level Pegs are used to achieve a level surface. Use them with your leveling unit. Cut to height and stick this flexible, self-adhesive rubber / vinyl peg right to the substrate. Pour leveling product right over the top. The peg will not float to the surface and becomes part of the cement matrix. Gauged in millimeters up to 65 mm (2-1/2").

ITEM #	DESCRIPTION
46280	Stick-Ems™ Level Pegs



Self Leveling Kits

Complete kit includes all the items required to mix and install self-leveling products. Tools pre-assembled and ready to use

ITEM #	DESCRIPTION
67410	8 Piece Self-Leveling Kit



FLOOR MERCHANDISERS: Floor merchandisers can double or triple your inventory turns by attracting customer attention and maximizing space efficiently. We have several options available and can customize a display to fit your needs.

360 DEGREE TOWER MERCHANDISER

The 360 degree tower merchandiser only takes up 3 square feet of floor space and provides complete display of tools from three sides. Options are available which allow for all types of hooks and baskets to be utilized. Comes complete with gridwall, hooks, and full color signage.



SKU - 58015
NO TOOLS INCLUDED



SKU - 58016
NO TOOLS INCLUDED

MORE MERCHANDISER OPTIONS



MINI 2' MERCHANDISER

SKU - 58013
NO TOOLS INCLUDED



BROOM DISPLAY RACK

SKU - 82999
NO TOOLS INCLUDED



EXTENSION HANDLE RACK

SKU - YDIS100
NO TOOLS INCLUDED

ITEM #	DESCRIPTION
58013	Mini 2' Standard Display Rack - No Tools Included
58015	Merchandiser Display - Grids & Signs, Catalogs, Hooks - No Tools Included
58016	Merchandiser Display - Slatgrids & Signs, Catalogs, Hooks - No Tools Included
82999	Broom Merchandiser Rack
YDIS003	4" Black Steel Gridwall Hook
YDIS004	9" Black Steel Magazine Holder for Gridwall
YDIS008	8" Black Steel Gridwall Hook
YDIS100	Midwest Rake® Pole Rack Display NEW
YDIS107	10" Black Steel Pegboard Hook
YDIS181	10" x 36" Midwest Rake® Sign
YDIS185	12" x 24" Coating Application Sign

ITEM #	DESCRIPTION
YDIS191	T-Shaped Legs for Gridwall
YDIS214	36" x 36", Broom Display Rack
YDIS222	12" x 6" Acrylic Gridwall Shelf
YDIS224	22" x 7" Sign Holder for Gridwall
YDIS243	144" x 15" Three-Part Coatings Sign
YDIS244	48" x 15" Midwest Rake® Sign
YDIS274	10" x 48" Midwest Rake® Sign
YDIS290	4" Black Steel Pegboard Hook
YDIS291	18" Black Adjustable Roller Cover Basket for Pegboard
YDIS292	Double Sided Roller Hanger for Pegboard
YDIS293	2' x 6' Black Steel Slatgrid
YDIS294	2' x 8' Black Steel Slatgrid

MIDWEST RAKE®

COATINGS APPLICATION TOOLS, APPLICATORS & SUPPLIES

SEYMOUR MIDWEST • P.O. BOX 1674, WARSAW, IN 46581-1674 • MIDWESTRAKE.COM
P 844-SEYMOUR (739-6687) • 574-267-7875 • F 574-267-8508

